

Drawings & Models

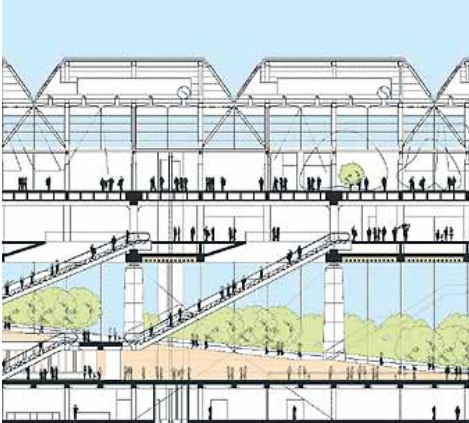

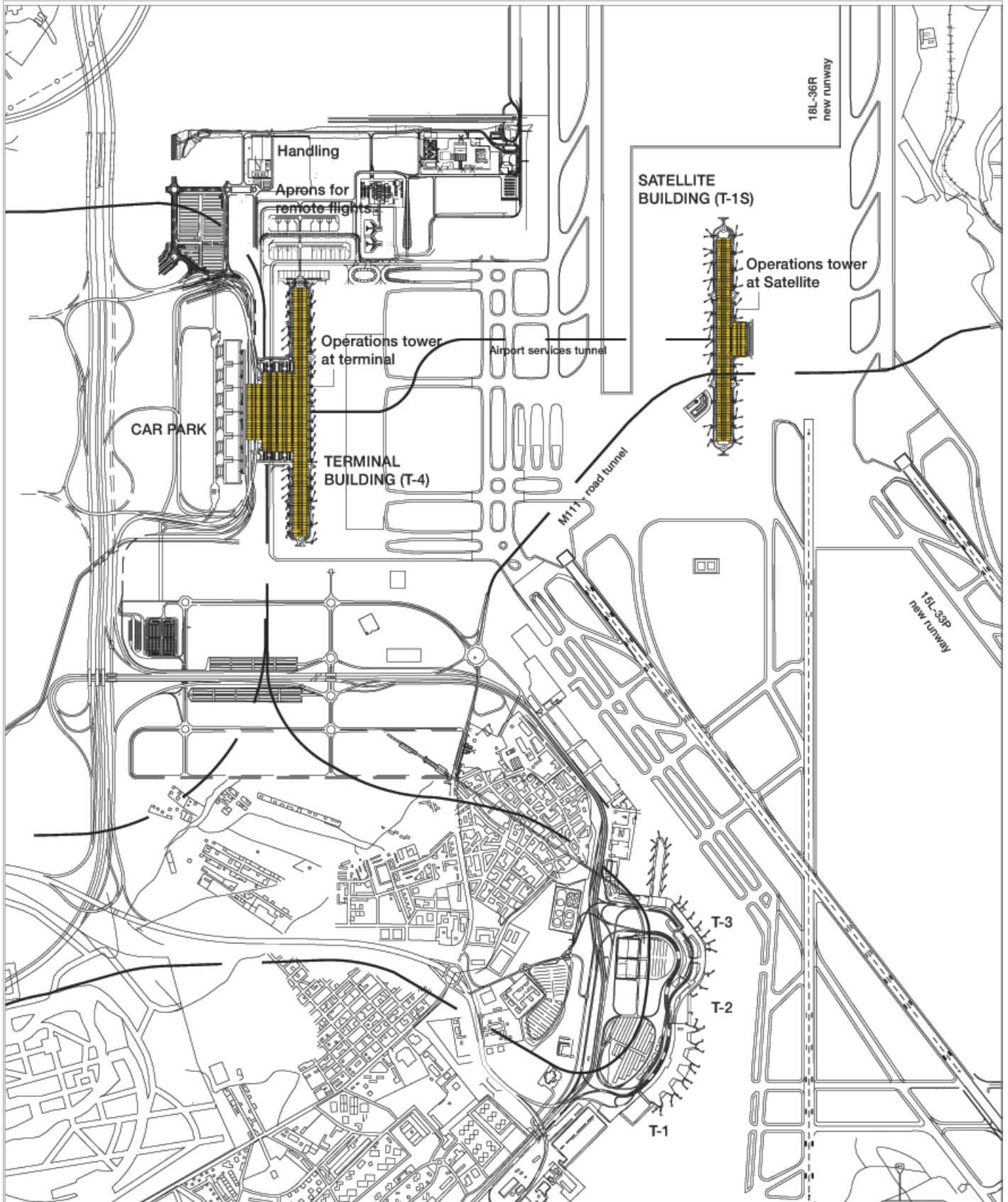







Terminal level +2

Image Number : 2642_0441_3



-  Airside Passengers
-  Landside Passengers
-  Vertical & Horizontal circulation
-  Retail
-  Airport services
-  Luggage handling automatic system

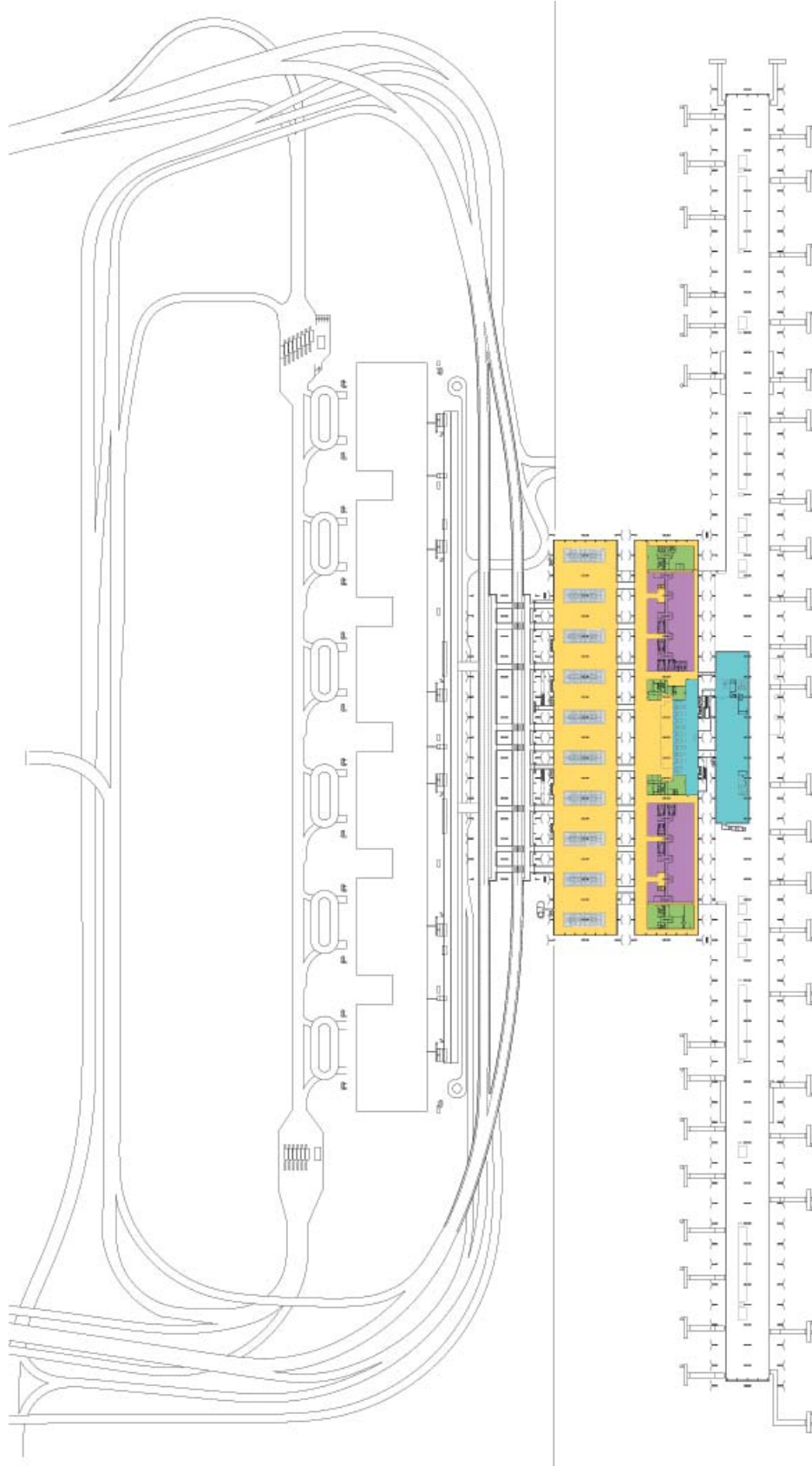

Terminal level +1

Image Number : 2642_0442_3





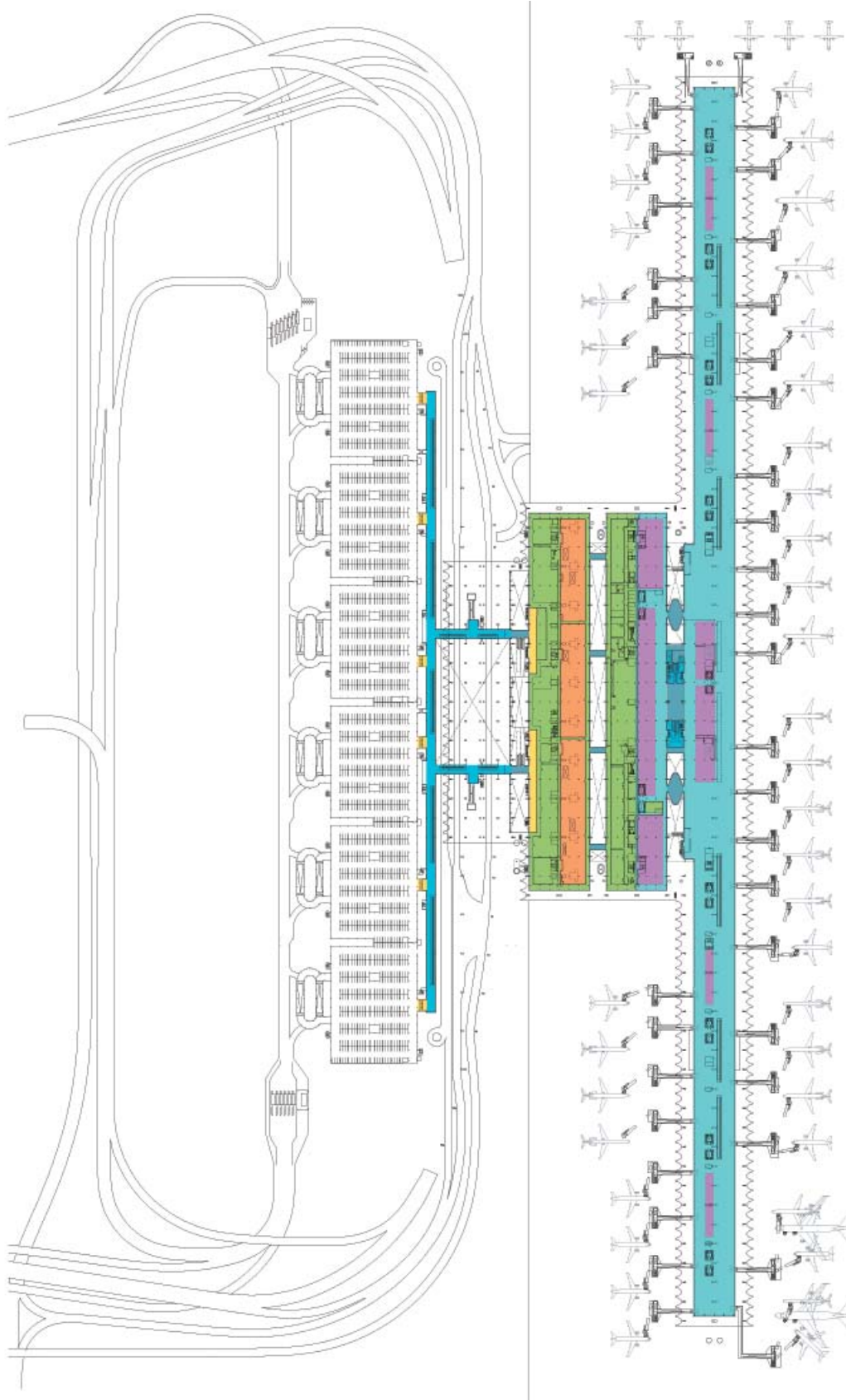



- Airside Passengers
- Landside Passengers
- Vertical & Horizontal circulation
- Retail
- Airport services
- Luggage handling automatic system



Terminal level 0

Image Number : 2642_0444_3



-  Airside Passengers
-  Landside Passengers
-  Vertical & Horizontal circulation
-  Retail
-  Airport services
-  Luggage handling automatic system









New Area Terminal (Terminal 4) Barajas
Madrid, Spain 1997 - 2006

Credit: N/A
Copyright: N/A

Terminal level -2

Image Number : 2642_0552_3



-  Airside Passengers
-  Landside Passengers
-  Vertical & Horizontal circulation
-  Retail
-  Airport services
-  Luggage handling automatic system

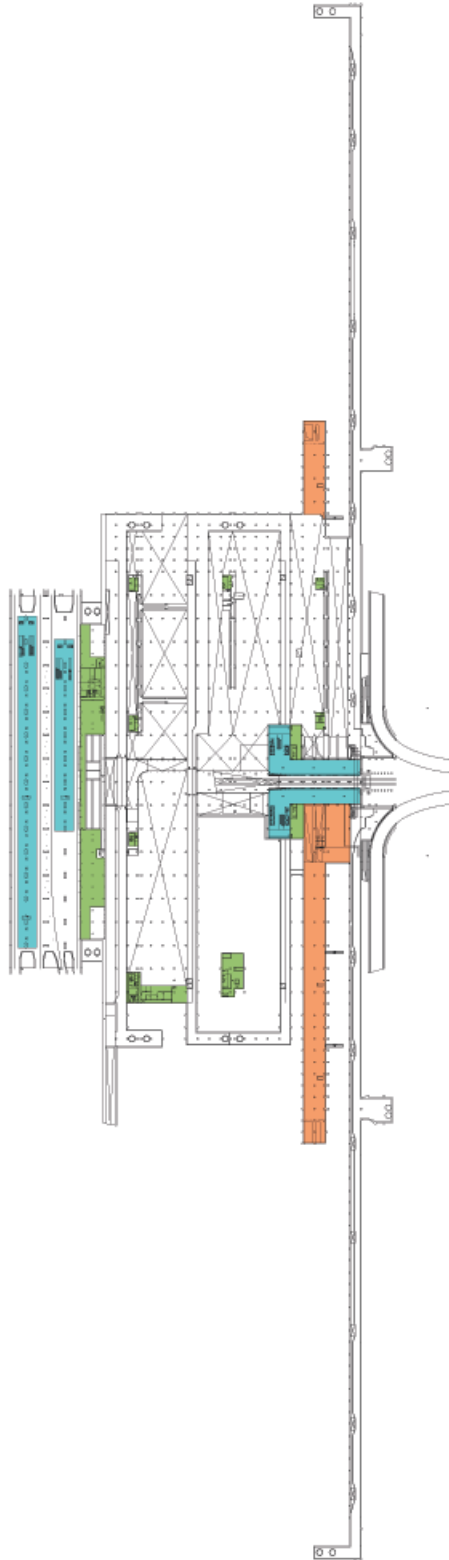

Elevations & Sections

Image Number : 2642_0443_1 & 2642_0448_1

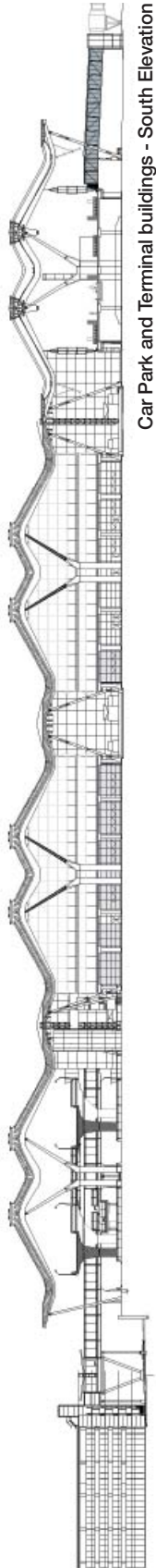

Car Park and Terminal buildings - South Elevation

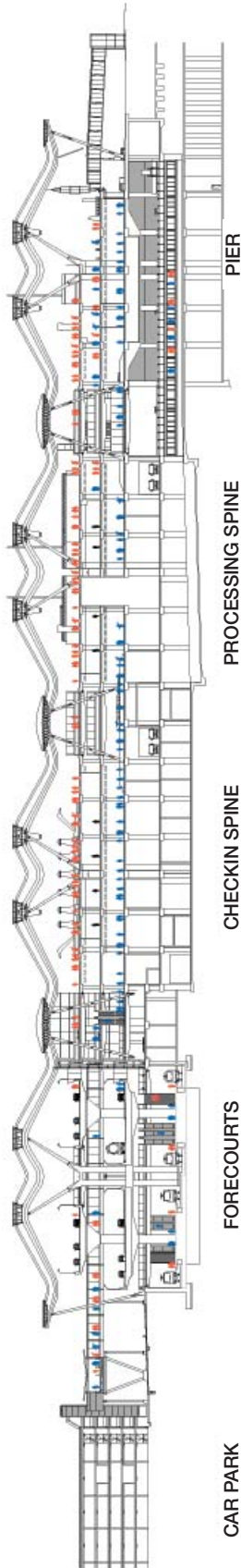

Car Park and Terminal buildings - Section



Satellite Building - South Elevation



Satellite Building - Section

Satellite level +2

Image Number : 2642_0445_3



- Airside Passengers
- Landside Passengers
- Vertical & Horizontal circulation
- Retail
- Airport services
- Luggage handling automatic system

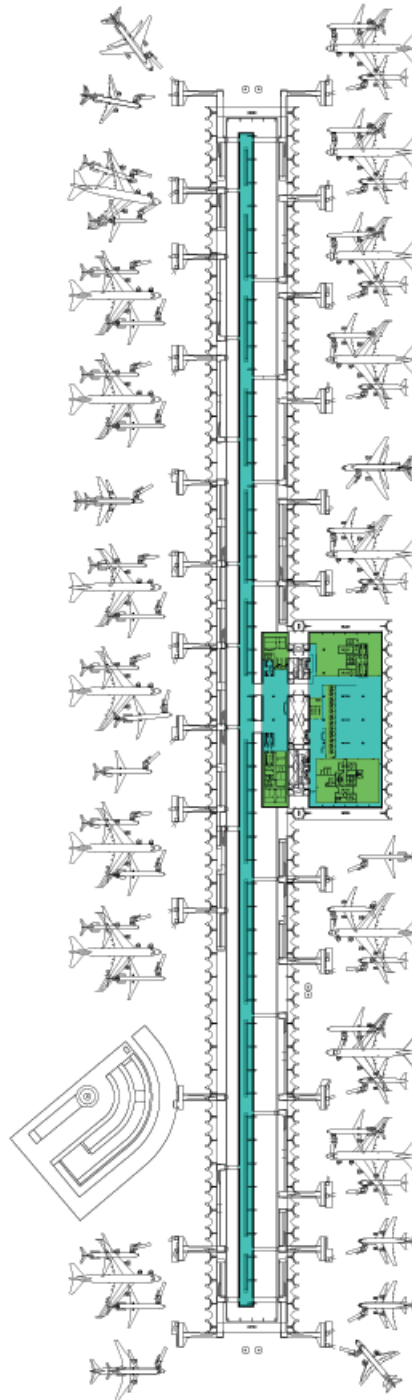

Satellite level +1

Image Number : 2642_0446_3



- Airside Passengers
- Landside Passengers
- Vertical & Horizontal circulation
- Retail
- Airport services
- Luggage handling automatic system

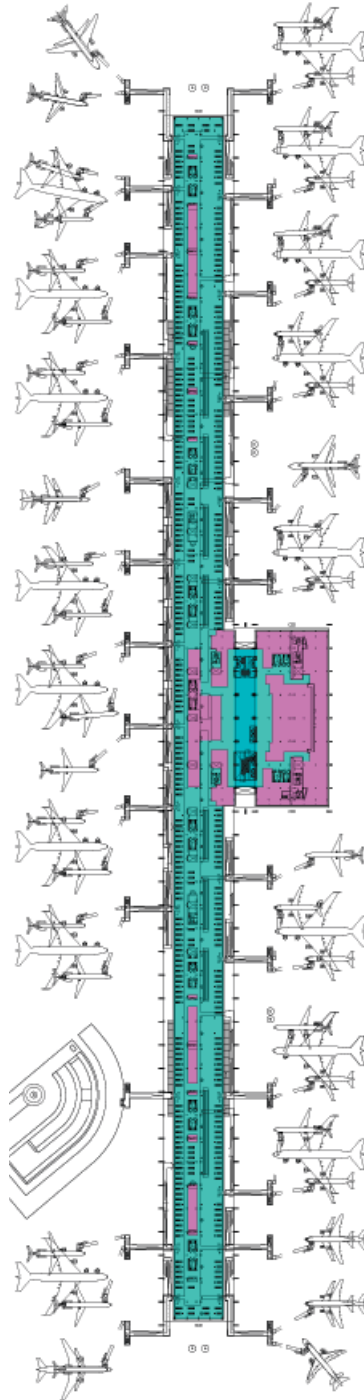

Satellite level 0

Image Number : 2642_0447_3





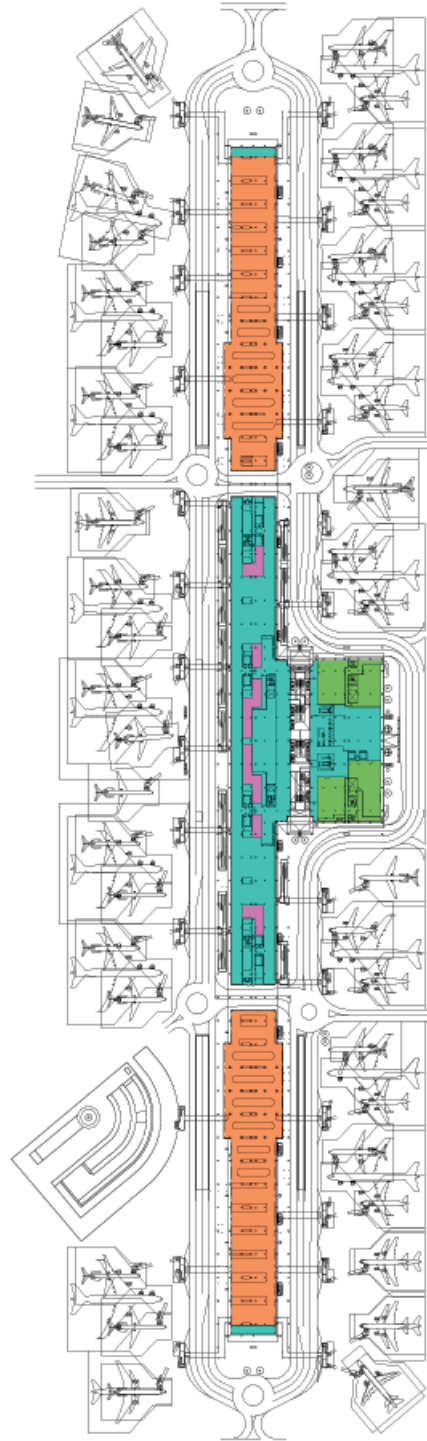



- Airside Passengers
- Landside Passengers
- Vertical & Horizontal circulation
- Retail
- Airport services
- Luggage handling automatic system



Satellite level -2

Image Number : 2642_0558_3



-  Airside Passengers
-  Landside Passengers
-  Vertical & Horizontal circulation
-  Retail
-  Airport services
-  Luggage handling automatic system

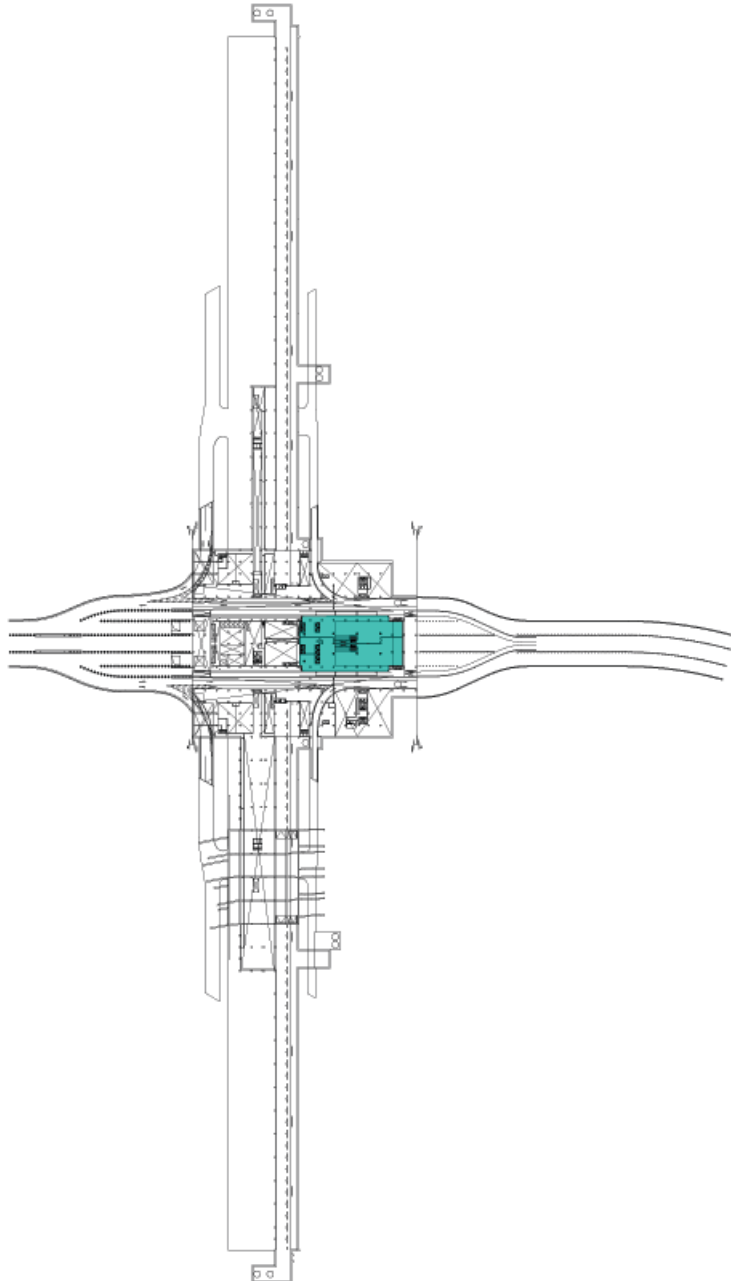

Cut-away isometric

Image Number : 2642_0557_2

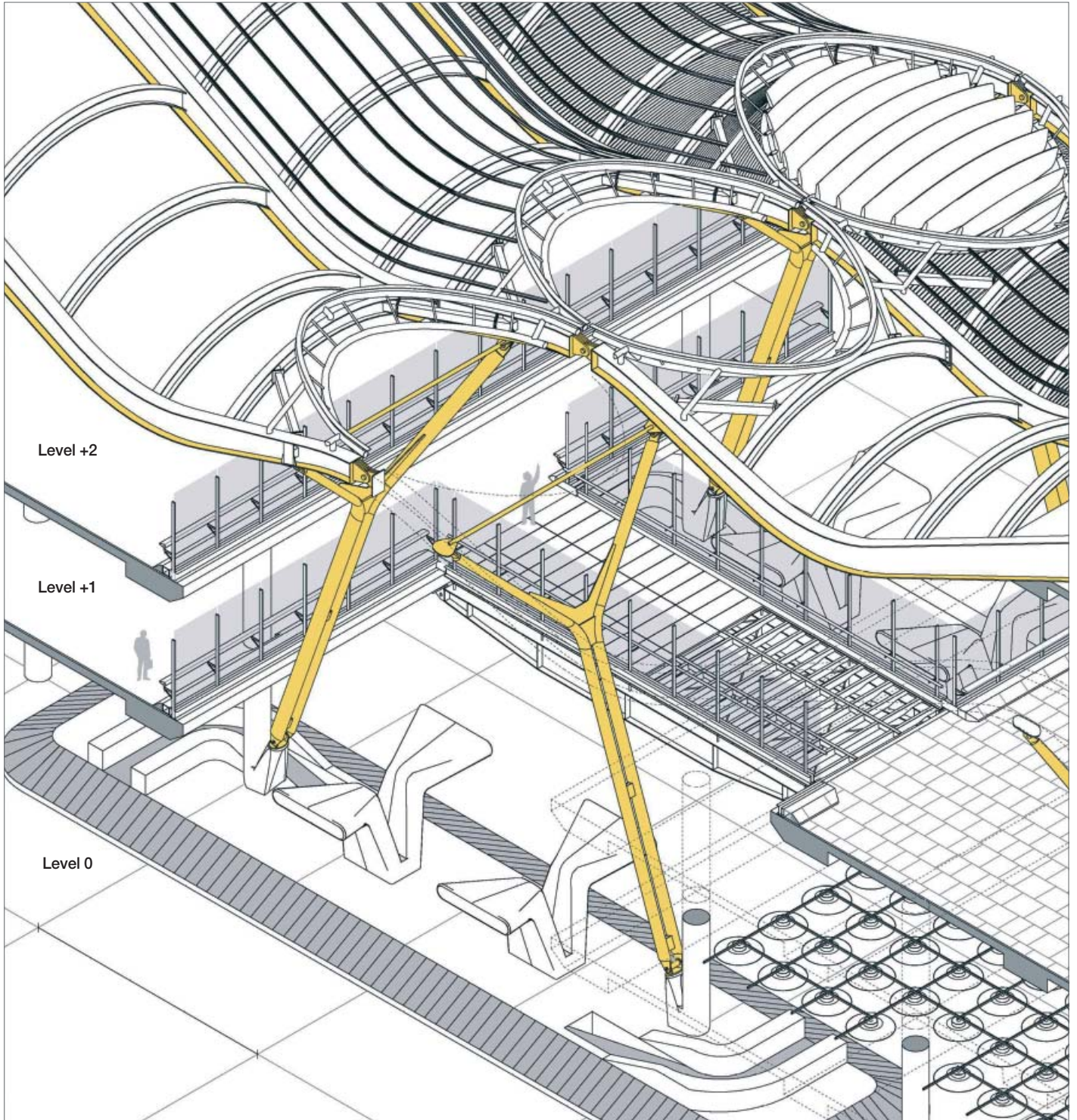

Terminal building 'B' canyon between check in and controls.
Luggage collection at level 0 and horizontal connections