

# edilportale<sup>®</sup>

## TOUR 2018

Efficienza Energetica, Antisismica,  
Comfort Abitativo, NTC2018, Illuminazione,  
Acustica, BIM, Realtà Virtuale

Genova, 16 Maggio 2018

**I SISTEMI A SECCO PER IL COMFORT ACUSTICO E L'EFFICIENZA  
ENERGETICA NELLA RISTRUTTURAZIONE**

**Ing. Emanuele Zaniboni**



Pareti perimetrali

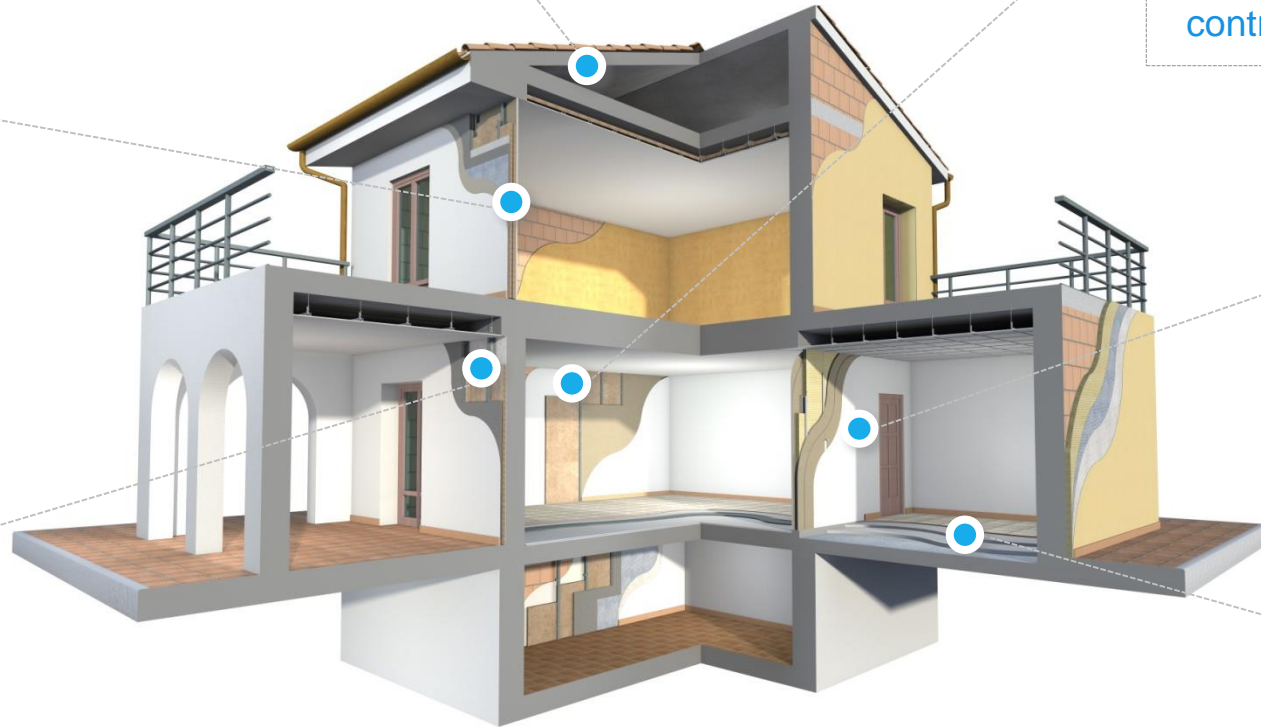

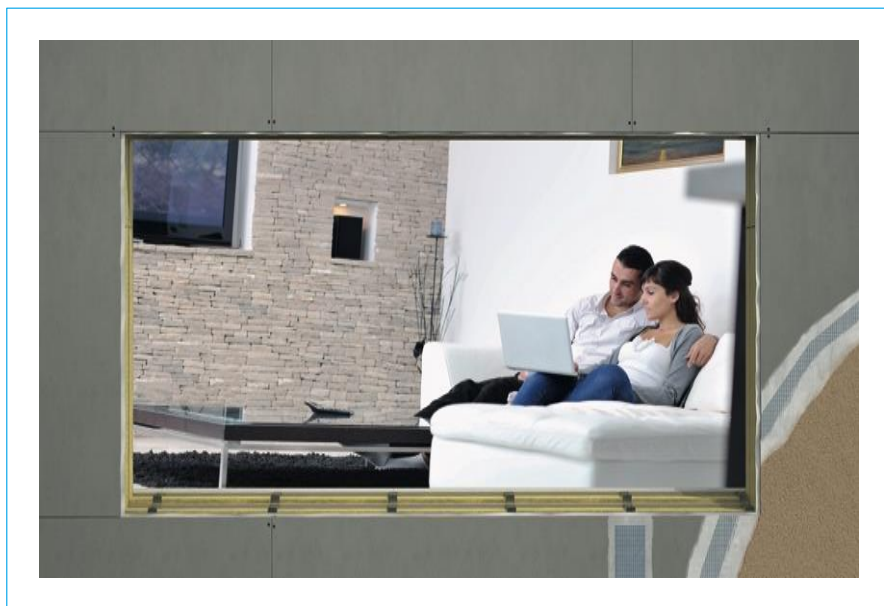

SISTEMA A SECCO PER ESTERNO

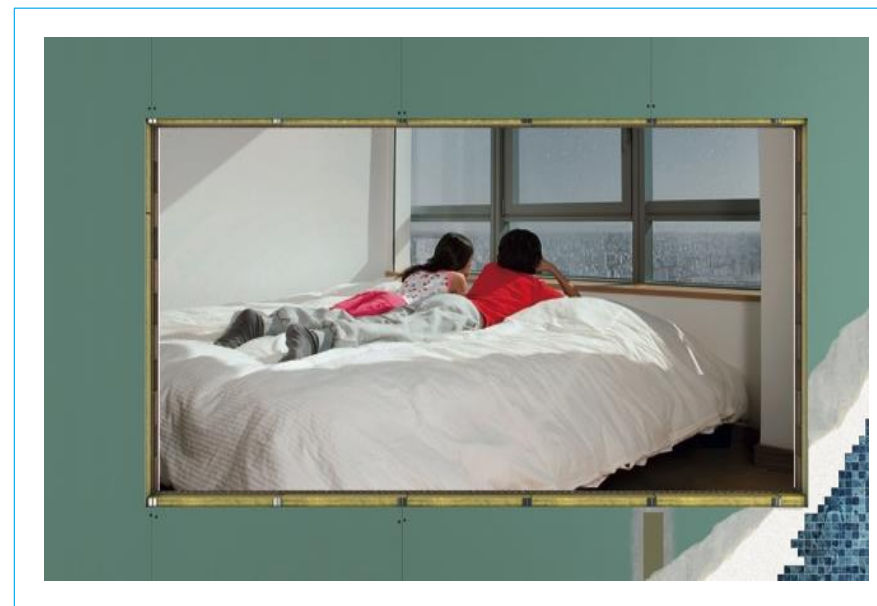

SISTEMA A SECCO PER INTERNO

Quali sono i vantaggi nel costruire completamente a secco?



### RISPARMIO ECONOMICO

- Tempi di costruzione più rapidi.
- Realizzazione più rapida dell'involucro  
= partenza anticipata dei lavori all'interno
  - Aumento della superficie utile.
- Costi complessivi dell'edificio inferiori.



### SOSTENIBILITÀ

- Riduzione fino al 50% del fabbisogno di energia primaria per la produzione.
- Riduzione del 30% di CO<sub>2</sub> grazie alla tecnica costruttiva che richiede spessori e pesi ridotti.
- Maggiore rispetto per l'ambiente grazie al minore consumo di risorse naturali.



### PRESTAZIONI

- Maggiori prestazioni a parità di spessore.
  - Edifici più leggeri.
- Ideali nelle ristrutturazioni senza necessità di consolidamenti.
  - Libera la fantasia progettuale.
  - Prestazioni sismiche superiori.

## Pareti di tamponamento

### Esempio di composizione di una parete esterna

Lastre AQUAPANEL® Outdoor  
+ accessori per finitura esterna

Orditura Knauf  
singola o doppia

Lastre Knauf in gesso rivestito e/o gessofibra,  
stucchi + opzioni per la finitura interna

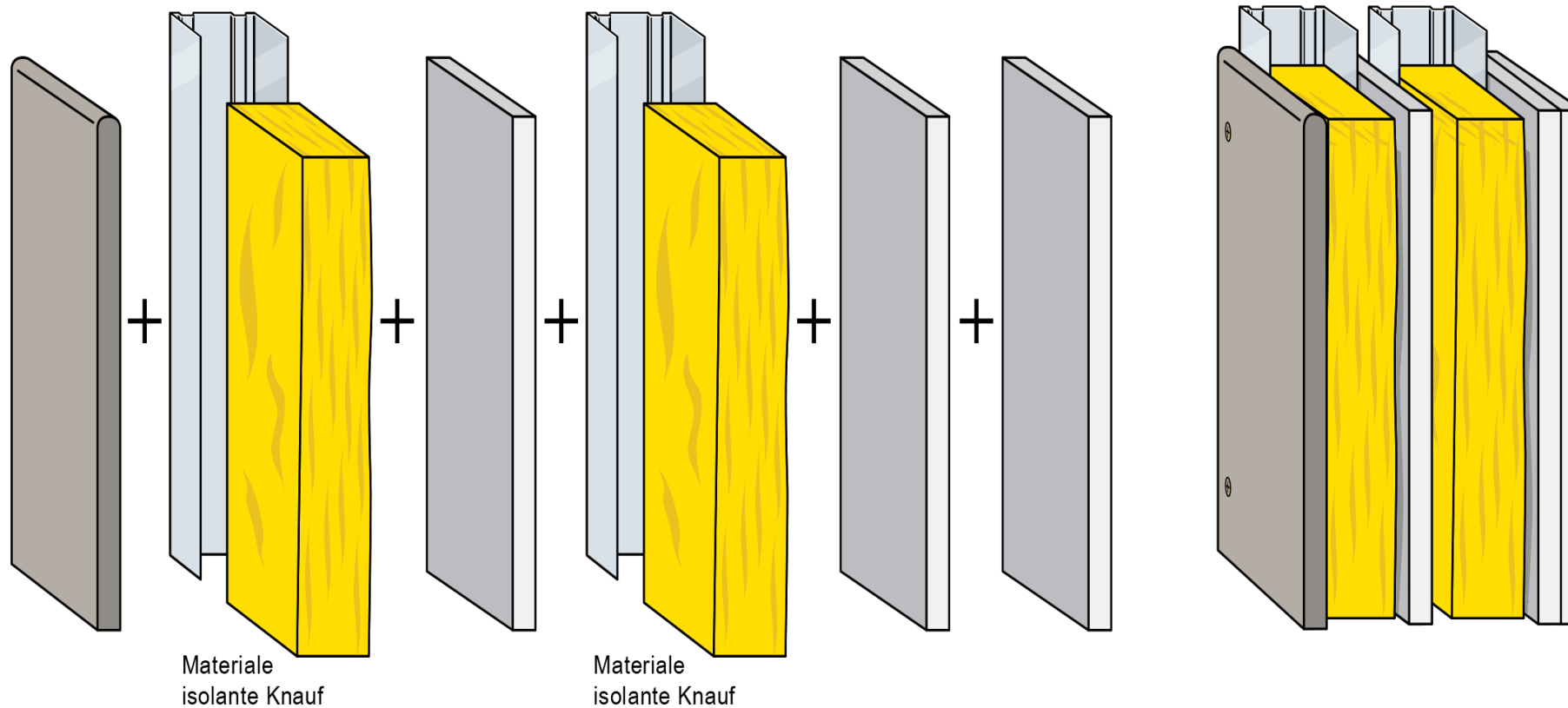





# SISTEMA A SECCO PER ESTERNO

**KNAUF INVOLUKRO**

**Sistema AQUAPANEL®**  
Leggerezza, resistenza e versatilità

## Pareti di tamponamento

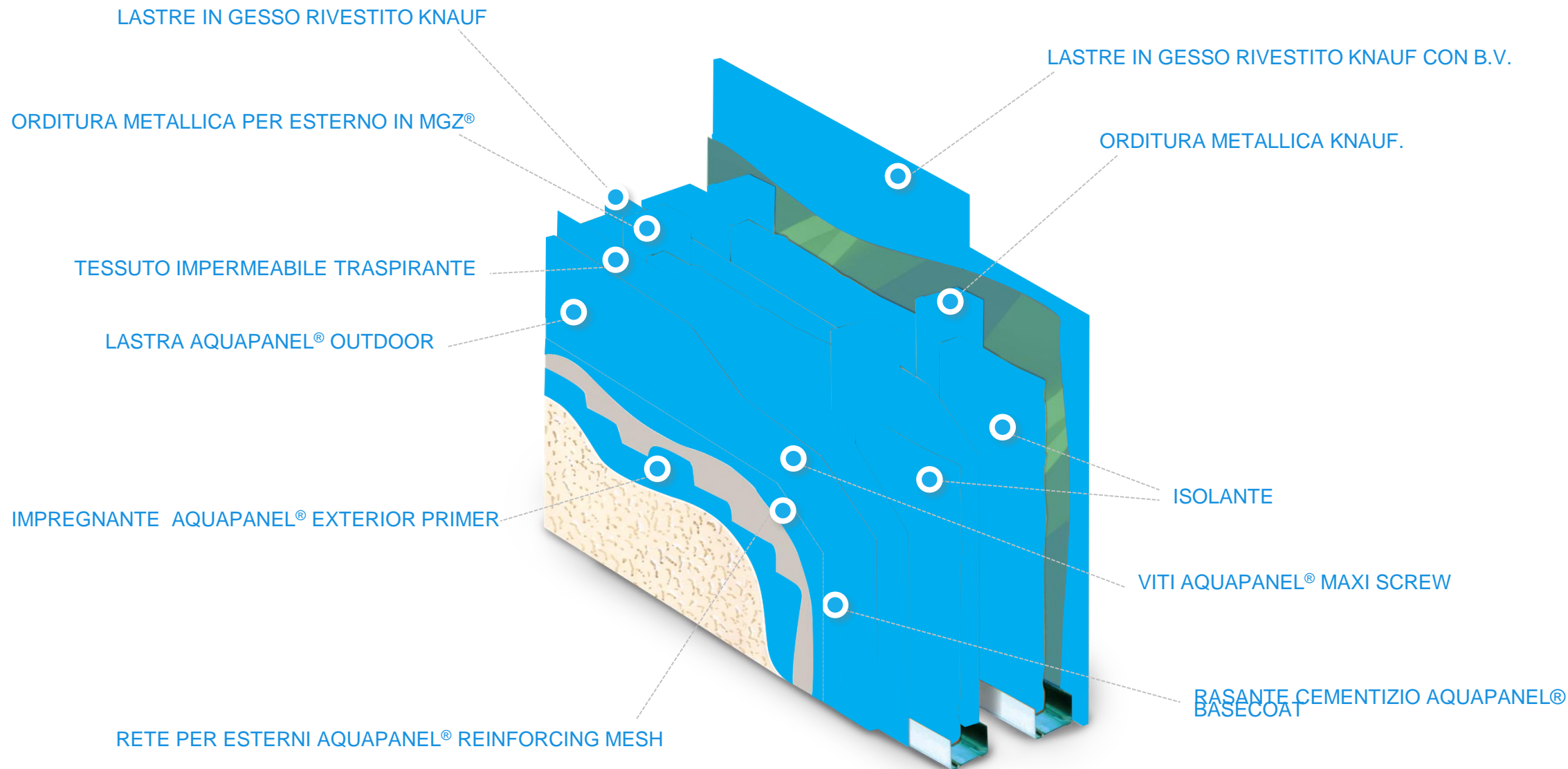



## Pareti di tamponamento: perché la doppia orditura?

- Andamento delle isoterme

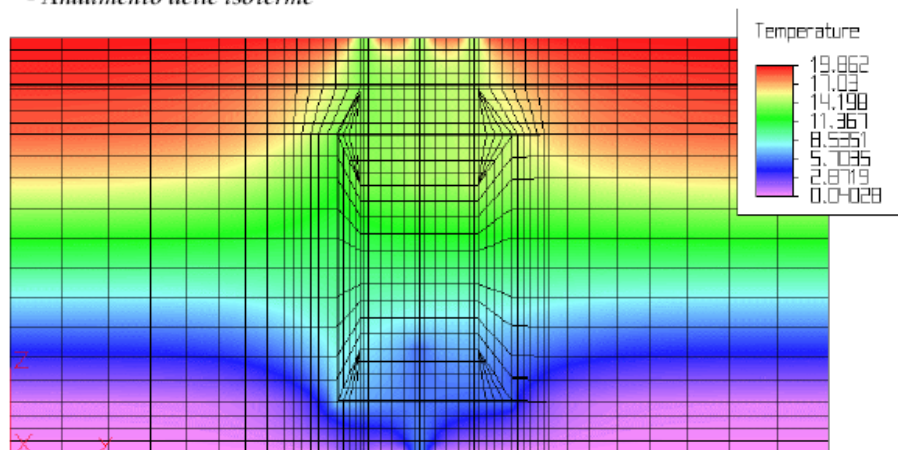

**PARETE A SINGOLA STRUTTURA**

Andamento delle isoterme

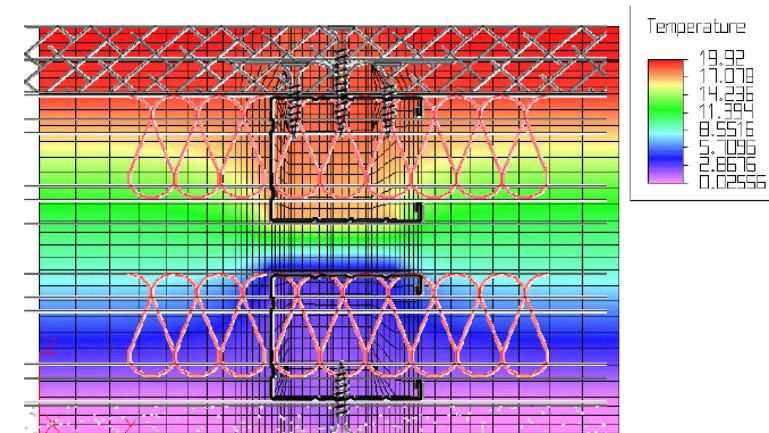

**PARETE A DOPPIA STRUTTURA**

## Le applicazioni: pareti di tamponamento - prestazioni

PONTI TERMICI SOLAIO/PILASTRO/TRAVI

### Esempio 1:

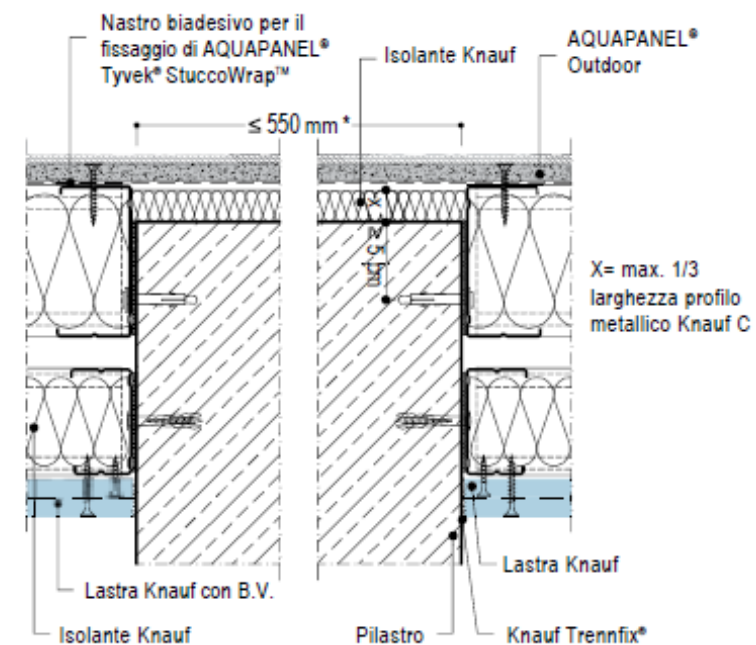
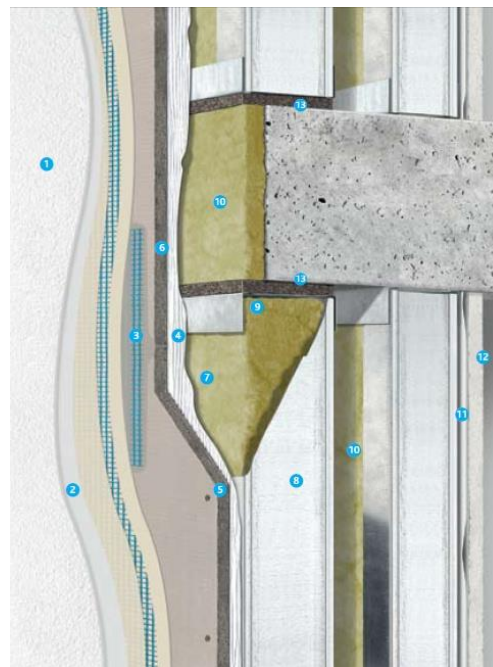
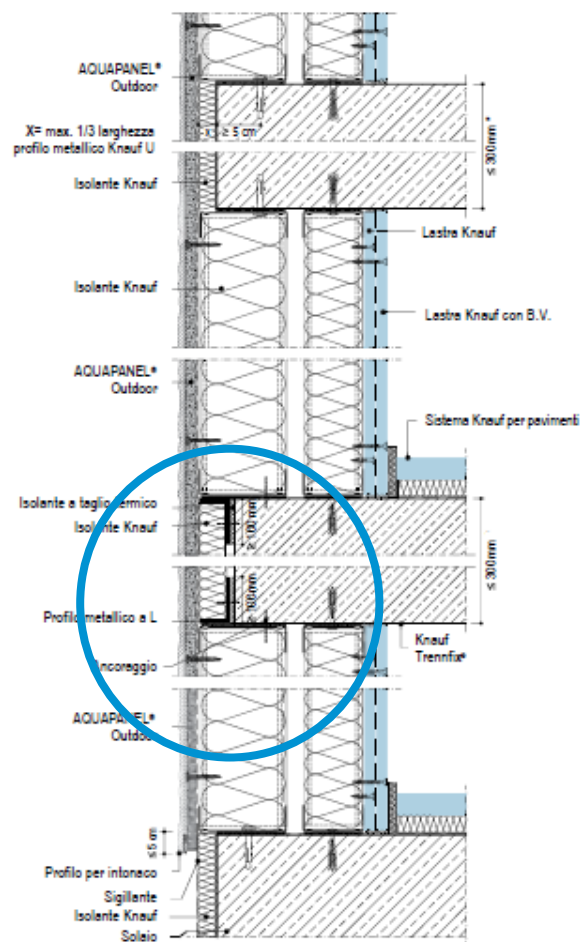

## Le applicazioni: pareti di tamponamento - prestazioni

PONTI TERMICI SOLAIO/PILASTRO/TRAVI

### Esempio 2:

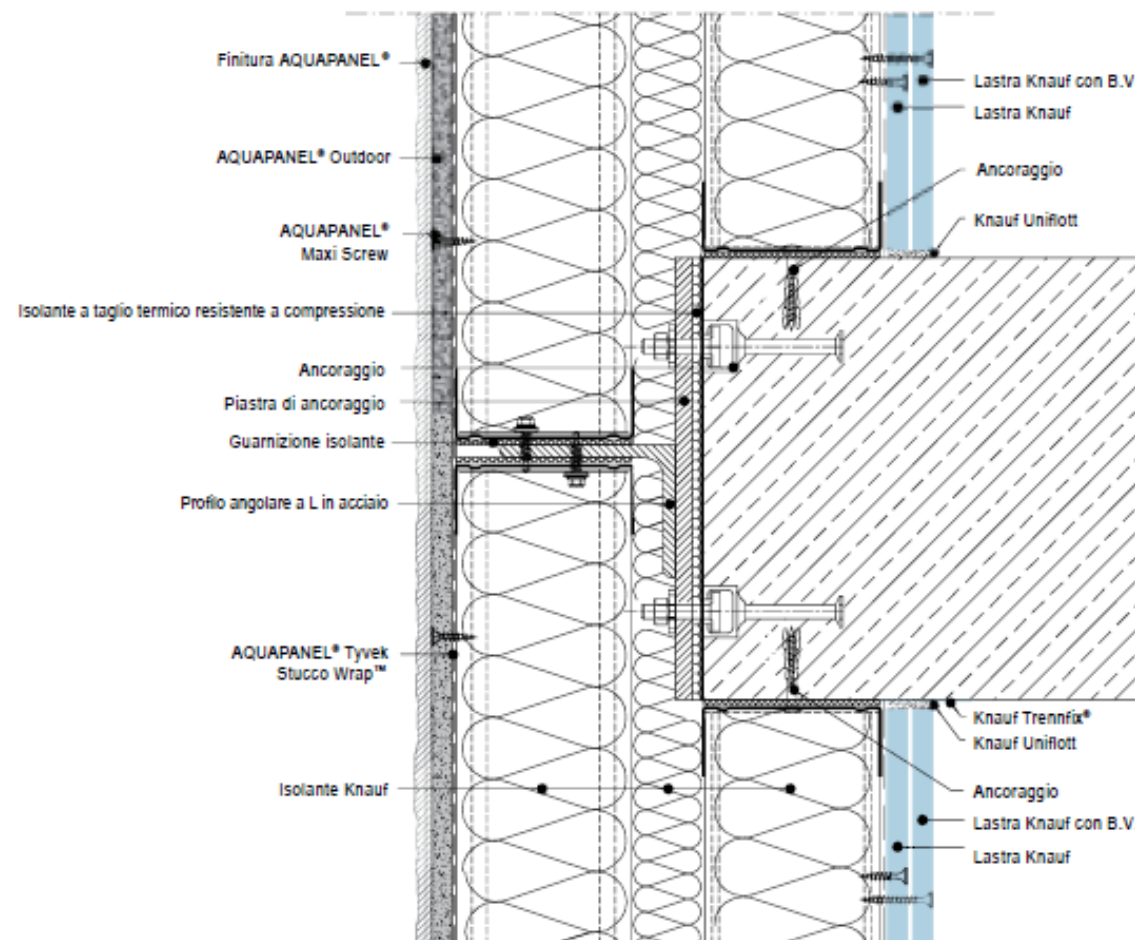
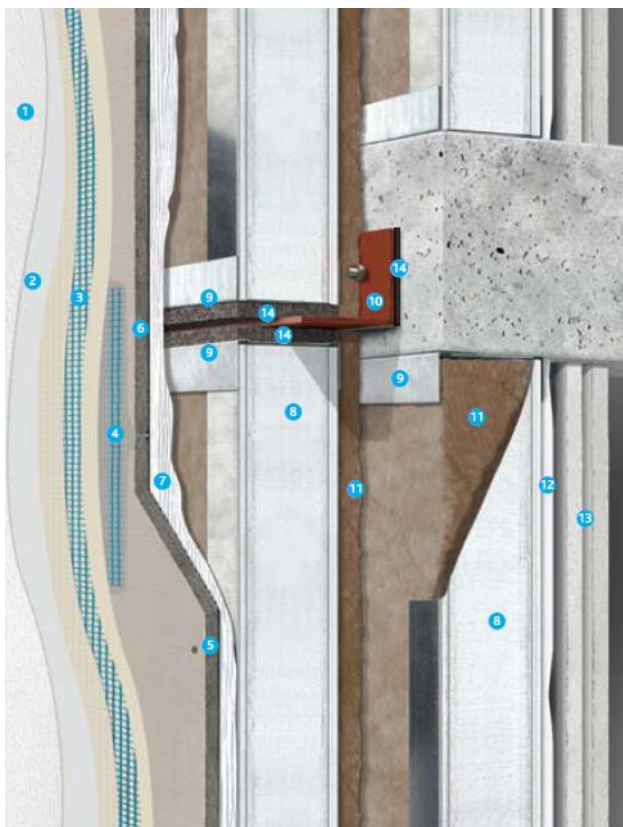

### Le applicazioni: pareti di tamponamento - prestazioni

#### Esempio 1:



## Le applicazioni: pareti di tamponamento - prestazioni

### Esempio 1:

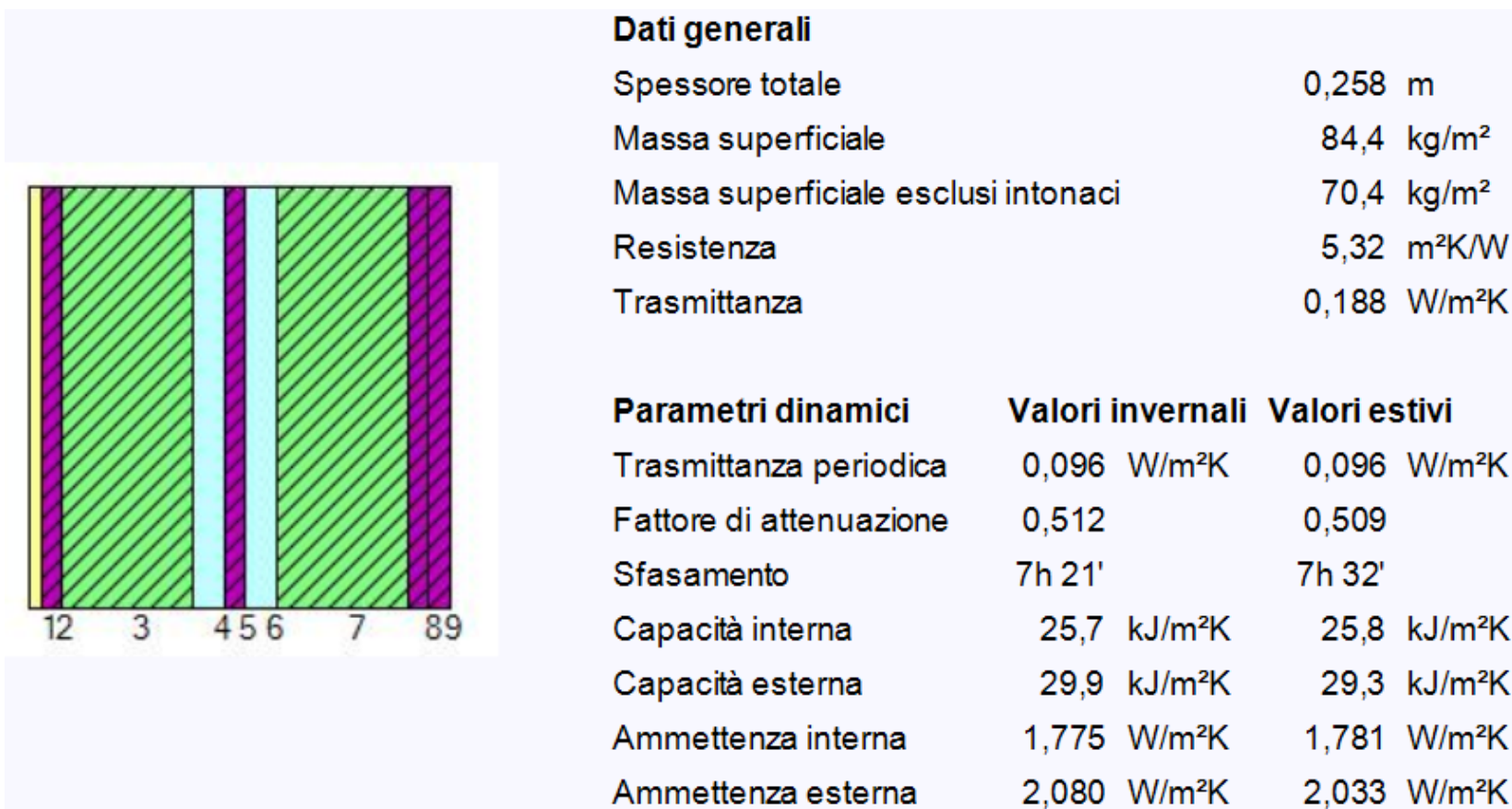

## Le applicazioni: pareti di tamponamento - prestazioni

**Esempio 2:**

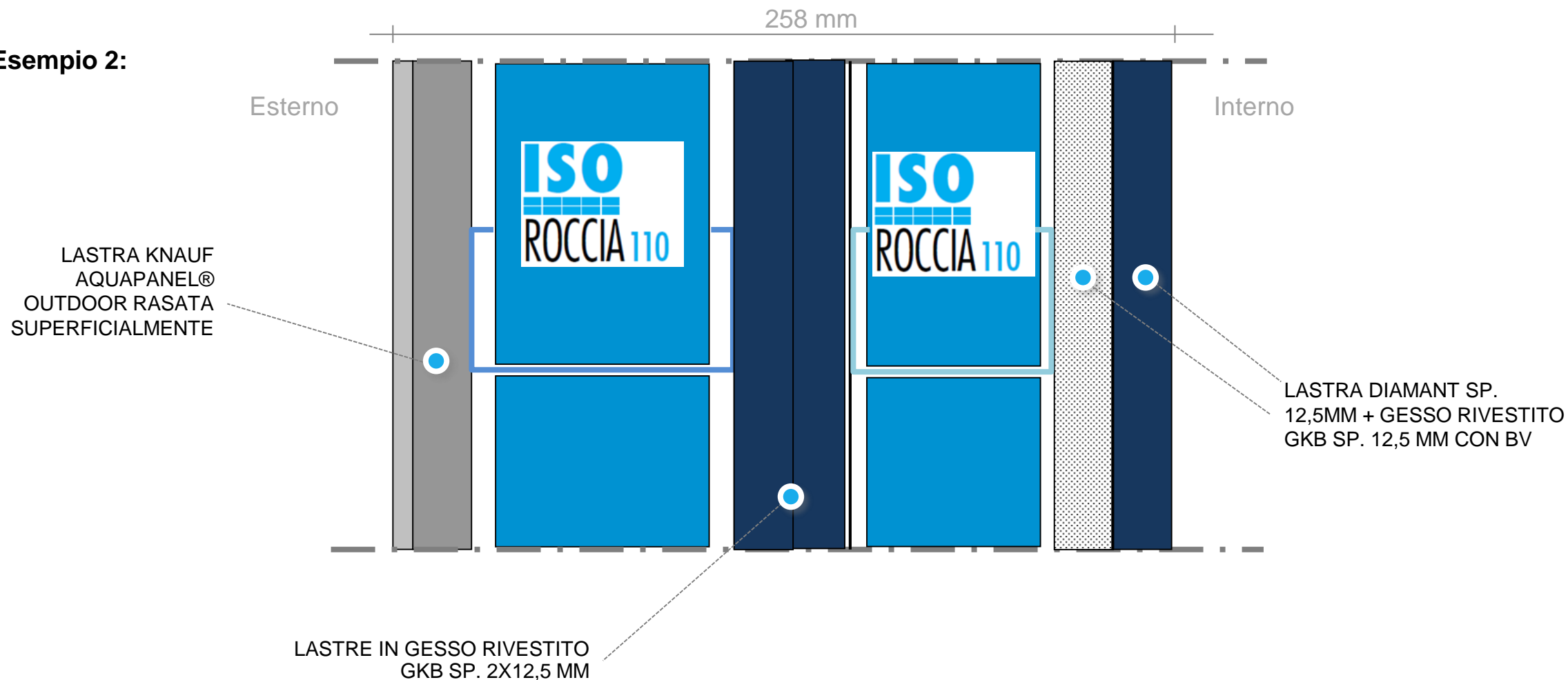

## Le applicazioni: pareti di tamponamento - prestazioni

Esempio 2:

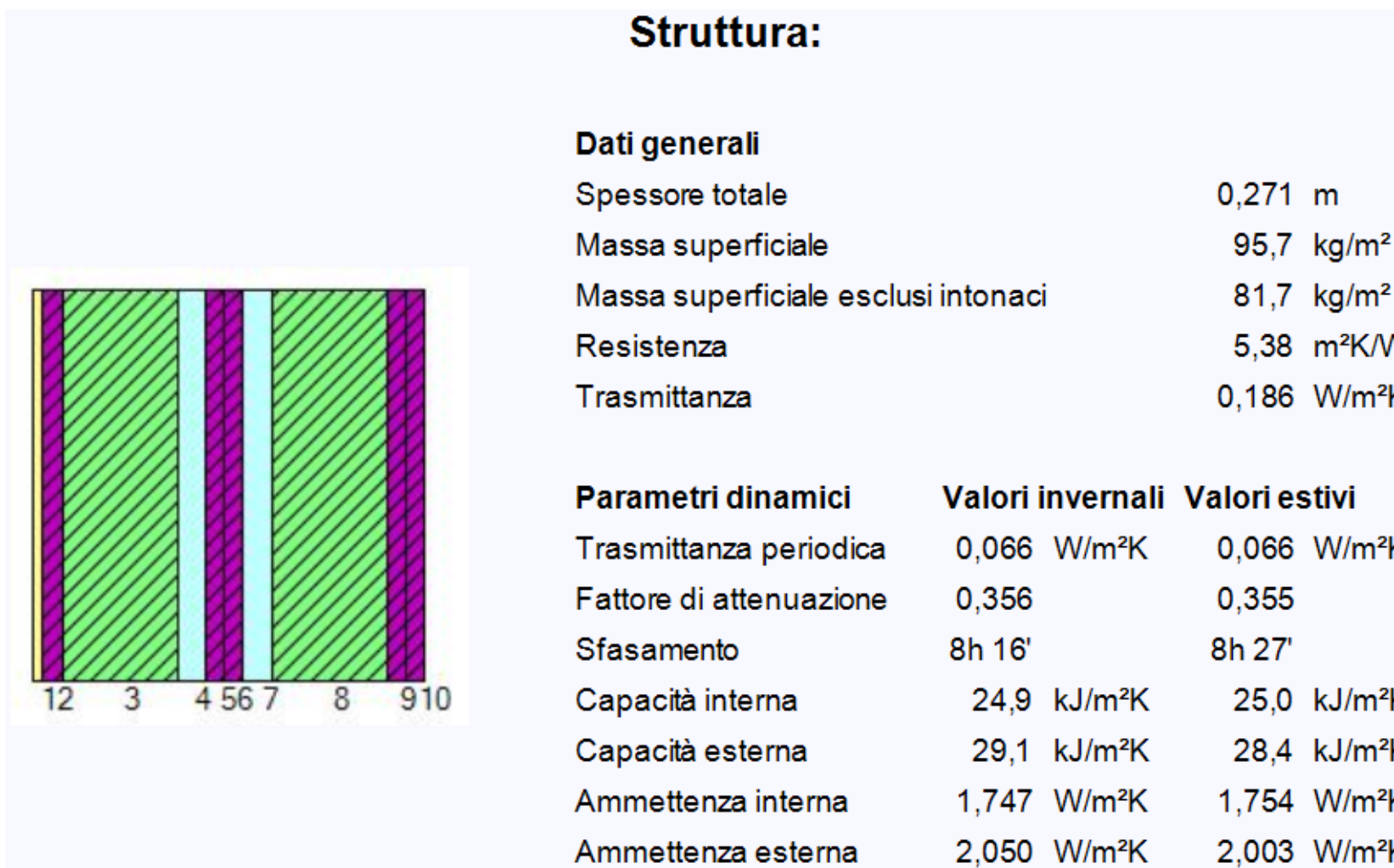

## Le applicazioni: pareti di tamponamento - prestazioni

ESEMPIO DI APPLICAZIONE SISTEMA AQUAPANEL + SISTEMA CAPPOTTO TERMICO

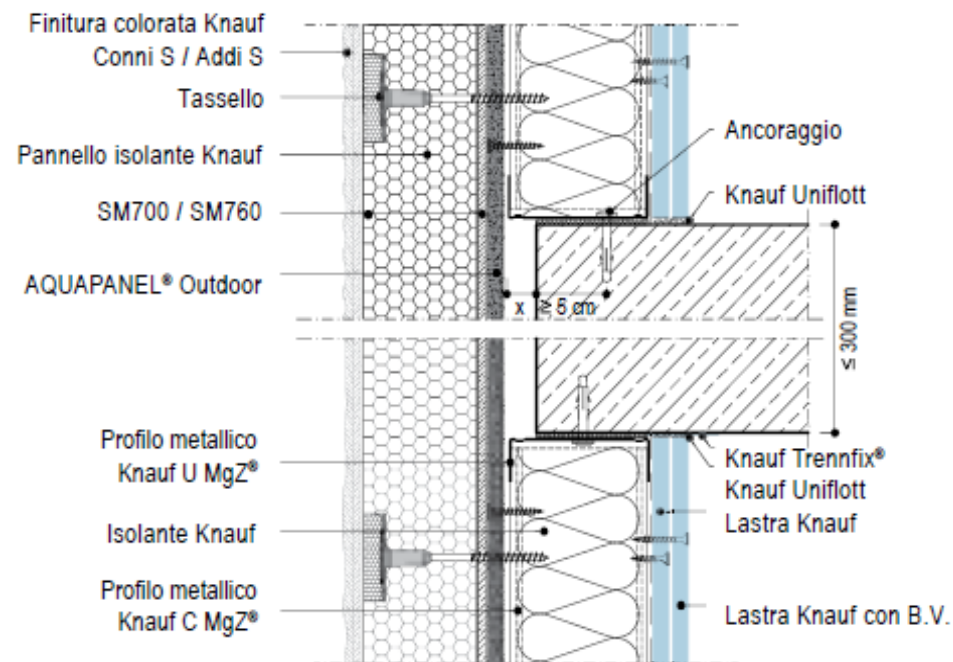



## Le applicazioni: pareti di tamponamento - prestazioni

ESEMPIO DI APPLICAZIONE SISTEMA AQUAPANEL + SISTEMA CAPPOTTO TERMICO

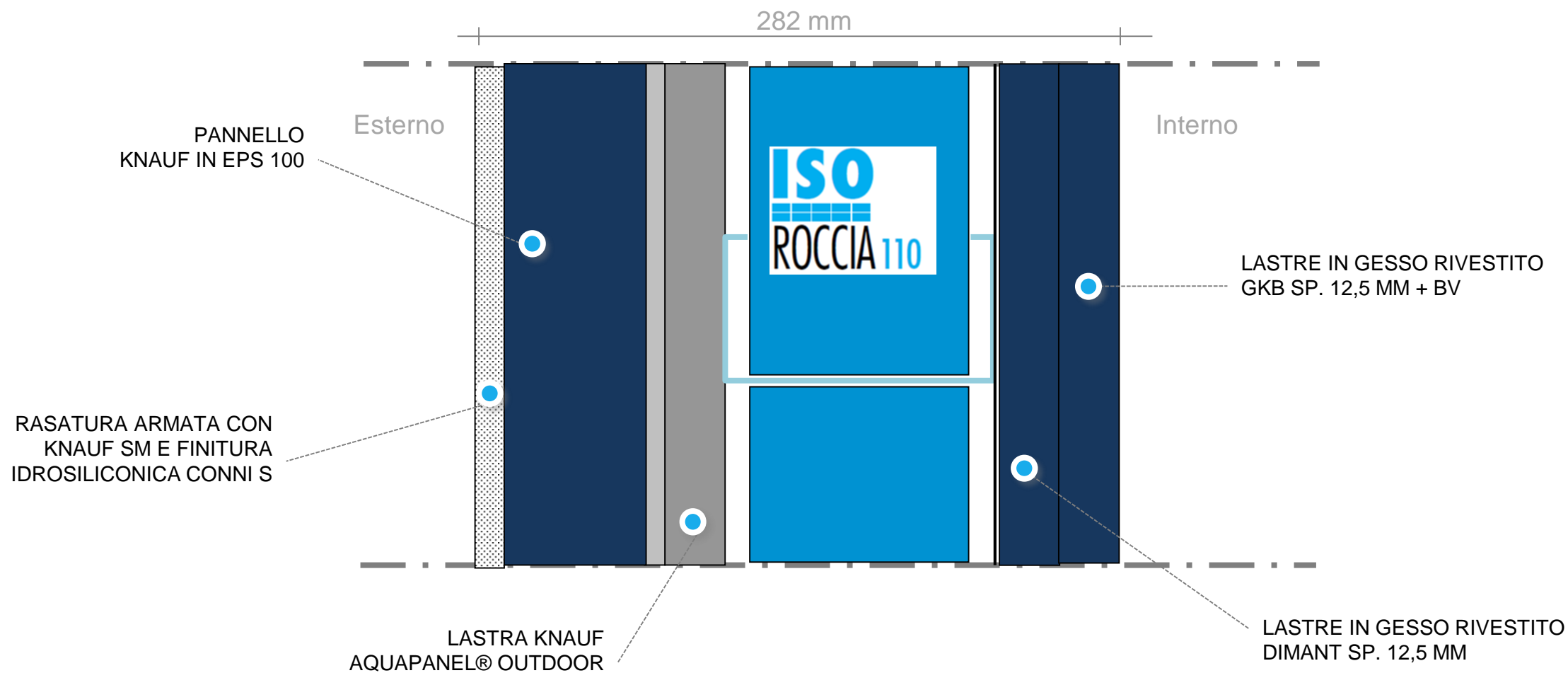

## Le applicazioni: pareti di tamponamento - prestazioni

ESEMPIO DI APPLICAZIONE SISTEMA AQUAPANEL + SISTEMA CAPPOTTO TERMICO

### Struttura:

#### Dati generali

Spessore totale	0,282 m
Massa superficiale	82,2 kg/m <sup>2</sup>
Massa superficiale esclusi intonaci	54,2 kg/m <sup>2</sup>
Resistenza	6,30 m <sup>2</sup> K/W
Trasmittanza	0,159 W/m <sup>2</sup> K

#### Parametri dinamici

#### Valori invernali Valori estivi

Trasmittanza periodica	0,041 W/m <sup>2</sup> K	0,041 W/m <sup>2</sup> K
Fattore di attenuazione	0,261	0,260
Sfasamento	8h 34'	8h 38'
Capacità interna	23,1 kJ/m <sup>2</sup> K	23,2 kJ/m <sup>2</sup> K
Capacità esterna	14,7 kJ/m <sup>2</sup> K	14,5 kJ/m <sup>2</sup> K
Ammettenza interna	1,639 W/m <sup>2</sup> K	1,648 W/m <sup>2</sup> K
Ammettenza esterna	1,030 W/m <sup>2</sup> K	1,014 W/m <sup>2</sup> K

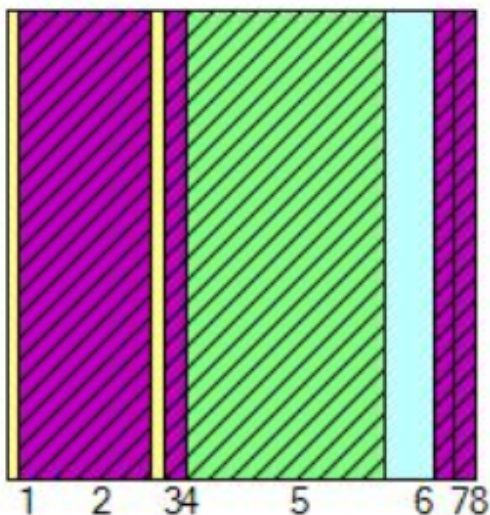



### RICERCA BIM



Knauf, leader nella tecnologia dei sistemi a secco applicata alle costruzioni civili, mette a disposizione di tutti i progettisti e addetti del settore un ampio ventaglio di soluzioni modellate con file BIM dedicati.

I file BIM Knauf agevolano il tecnico nelle varie fasi della sua attività, anche grazie al diversificato livello di dettaglio e di informazioni associate a ciascun elemento e alla relativa soluzione.

Sfruttando al meglio le potenzialità dei modelli virtuali BIM si raggiunge una realizzazione integrata della commessa con il controllo puntuale e progressivo delle fasi e delle parti coinvolte.

SCARICA FILE BIM KNAUF

COSE' IL BIM

SCARICA FILE BIM KNAUF

COSE IL BIM

### Ricerca Particolare BIM

Ricerca per Nome/Soluzione

Tipologia applicazione

Tutte ▼

Inizia Ricerca FILE BIM



W111 GKB EI30  
W111 – Lastra GKB – EI 30

PRESTAZIONI:

[↓ SCARICA SUBITO](#)



W111 GKI EI30  
W111 – Idrolastra GKI – EI 30

PRESTAZIONI:

[↓ SCARICA SUBITO](#)



W111 GKF EI60  
W111 – Ignilastra GKF – EI 60

PRESTAZIONI:

[↓ SCARICA SUBITO](#)



W361 Vidiwall EI60  
W361 – Lastra Vidiwall – EI 60

PRESTAZIONI:

[↓ SCARICA SUBITO](#)



W111 GKB EI30 Rw51  
W111 – Lastra GKB – EI 30 –  
Rw 51 dB



W112 GKB EI60 Rw54  
W112 – Lastra GKB – EI 60 –  
Rw 54 dB



W112 GKF EI120  
W112 – Ignilastra® GKF – EI 120



W112 Vidiphonic+GKF EI120  
Knauf W112 – Lastra  
Vidiphonic + GKF – EI 120.



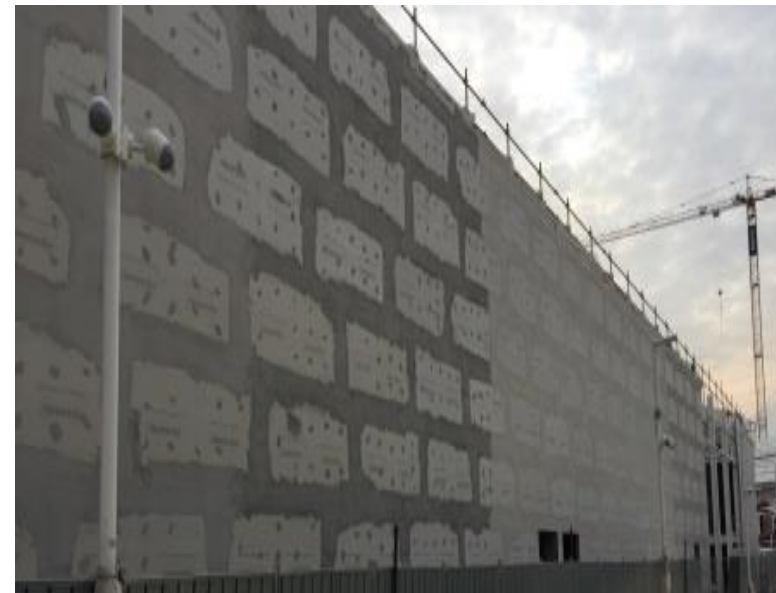









# SISTEMA ISOLAMENTO TERMOACUSTICO PER INTERNI



**Sistema Isolamento Interni**  
L'evoluzione del comfort termo-acustico

Per isolare bene: il concetto di una cella nella cella

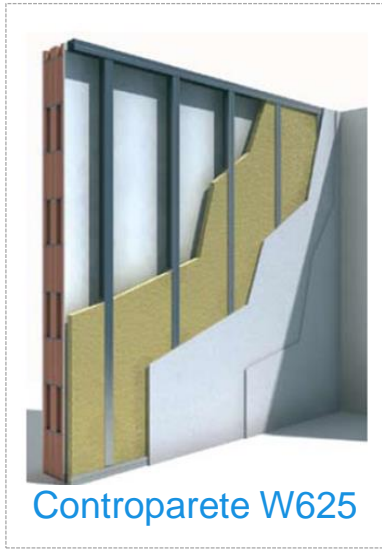

Controparete W625

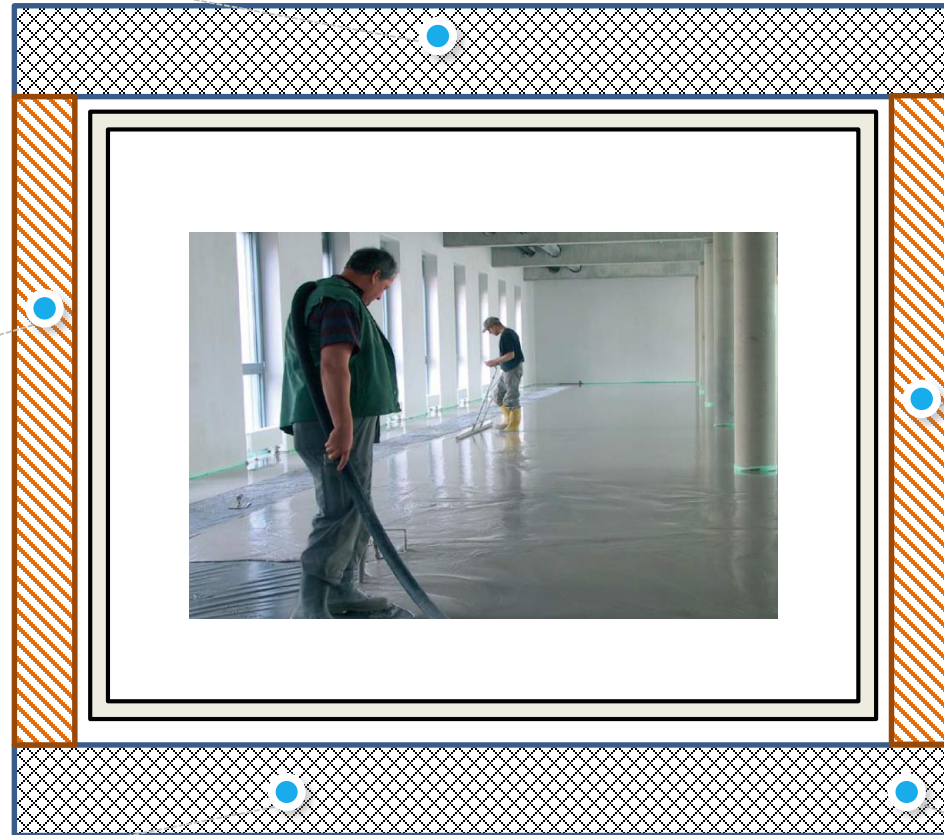

Rivestimento isolante W624

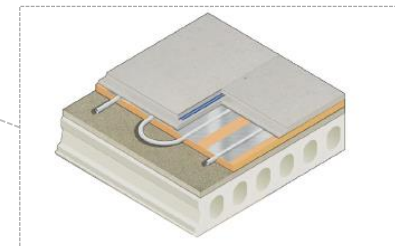

## Contropareti ad elevate prestazioni acustiche e termiche

Alcune soluzioni:

W624



W623

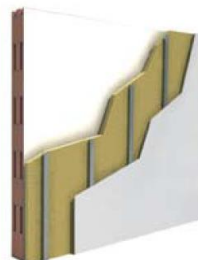

W625

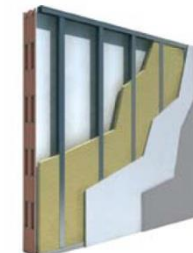

Potere Fonoisolante Rw (dB)	Tipo Lastra	Spessore Lastra (mm)	Isolante Spessore (mm)/ Densità (kg/m³)	Supporto (Muratura)	Certificato di prova	Sistema Knauf	Profondità Intercapedine (mm)	Massa superficiale Rivestimento kg/m²	Massa superficiale Parete kg/m²
Rw 64 C-4 Ctr -5	Vidiwall®	12,5	Isoroccia 40 2x40/40*	Laterizio forato sp. 12 cm senza intonaco	208451	2xW625	55 x 2 mm (controparete bifacciale)	19 x 2 kg/m² (controparete bifacciale)	70 kg/m²
Rw 63 C-2 Ctr -6	GKB	2x12,5	Ekovtro® P 60/14	Laterizio forato sp. 11,5 cm + 1,5 cm + 1,0 cm intonaco	223360	W625	60 mm	21 kg/m²	115 kg/m²
Rw 60 C-3 Ctr -10	GKB	12,5	Isoroccia 40 2x40/40*	Laterizio forato sp. 8 cm + 1,5 cm intonaco per lato	208453	2xW623	72 x 2 mm (controparete bifacciale)	13 x 2 kg/m² (controparete bifacciale)	66 kg/m²
Rw 55 C-4 Ctr -10	Isolastra® Diamant FPE	12,5	20/40	Laterizio forato sp. 8 cm + 1,5 cm intonaco per lato	310759	W624	-	18 kg/m²	117 kg/m²
Rw 57 C-3 Ctr -9	Isolastra® Diamant FPE	12,5	40/40	Laterizio forato sp. 8 cm + 1,5 cm intonaco per lato	310758	W624	-	19 kg/m²	117 kg/m²
Rw 59 C-2 Ctr -7	Silentboard®	12,5	Lana vetro 40 mm 21 kg/m³	Laterizio forato sp. 8 cm + 1,5 cm intonaco per lato	IG xxxx	W625	60 mm	21 kg/m²	160 kg/m²
Rw 64 C-3 Ctr -9	Silentboard® + GKB	12,5 + 12,5	Lana vetro 40 mm 15 kg/m³	Laterizio forato sp. 8 cm + 1 cm intonaco per lato	Zlab 147- 2014 IAP	W625	55 mm	28 kg/m²	65 kg/m²

## Controsoffitto in aderenza D111

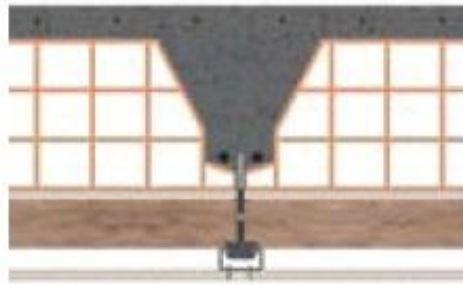

Solaio

Isolante

Profilo Knauf C Plus 27/50/27 mm,  
ad interasse 500 mm

Lastra Knauf GKB, spessore 12,5 mm  
con barriera al vapore in lamina  
di alluminio spessore 15 µm



**SILENTBOARD**

Rw 49 dB



Rw 63 dB



Rw > 68 dB

Ln,w 88 dB



Ln,w 61 dB



Ln,w 53 dB

Singola struttura e doppia lastra di rivestimento

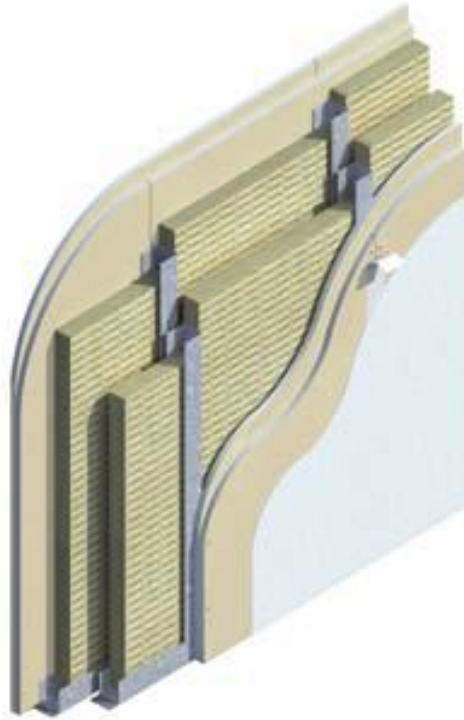

Rw 54 dB

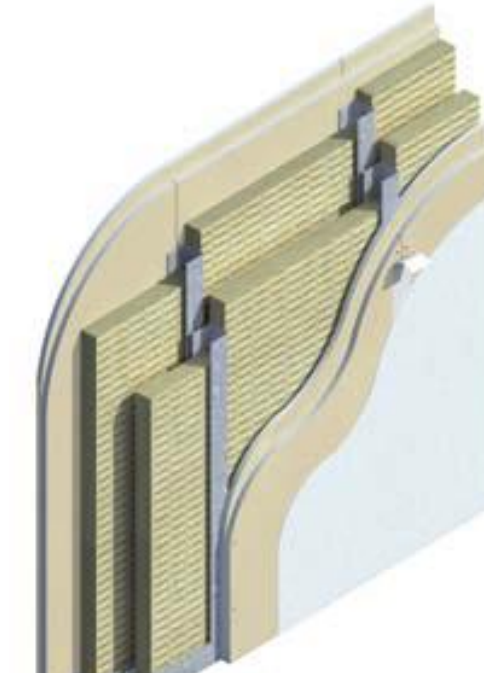

**DIAMANT**

Rw 56 dB

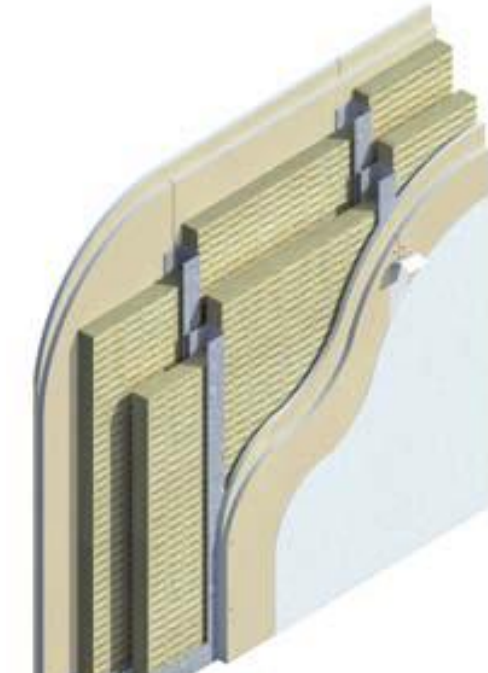

**SILENTBOARD**

Rw 66 dB

## Singola struttura e doppia lastra di rivestimento

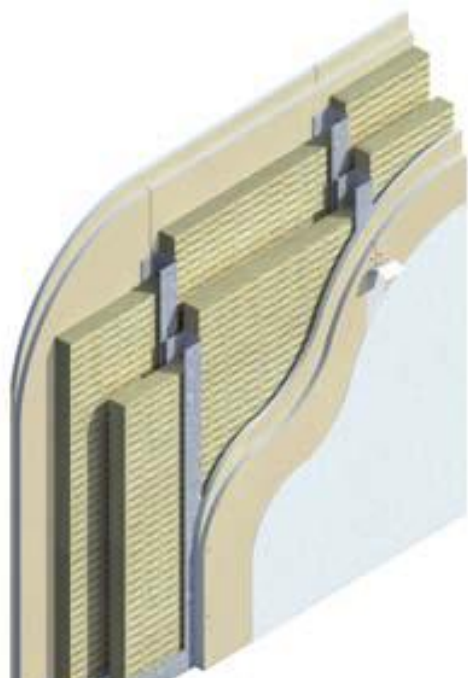

**SILENTBOARD**

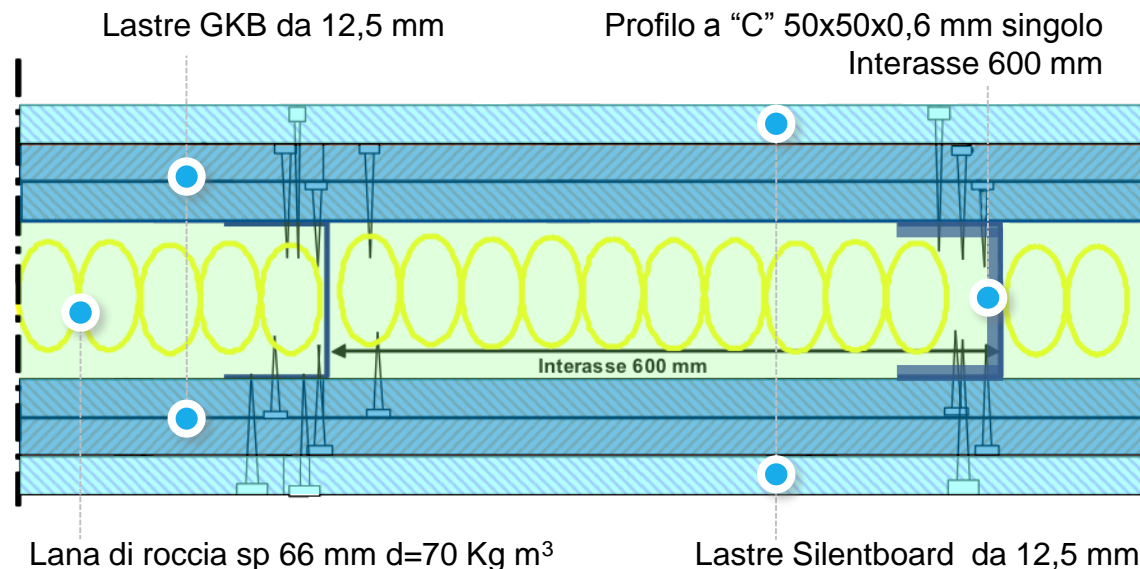

Spessore 100 mm, peso 43  $\text{kg/m}^2$   
 $R_w = 54 (-4; -10) \text{ dB}$



Spessore 125 mm, peso 54  $\text{kg/m}^2$   
 $R_w = 56 \text{ dB}$

Doppia struttura e doppia lastra di rivestimento

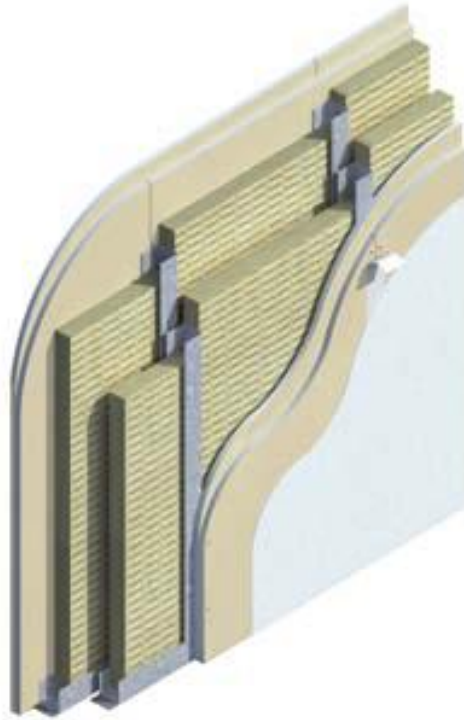

Rw 61 dB

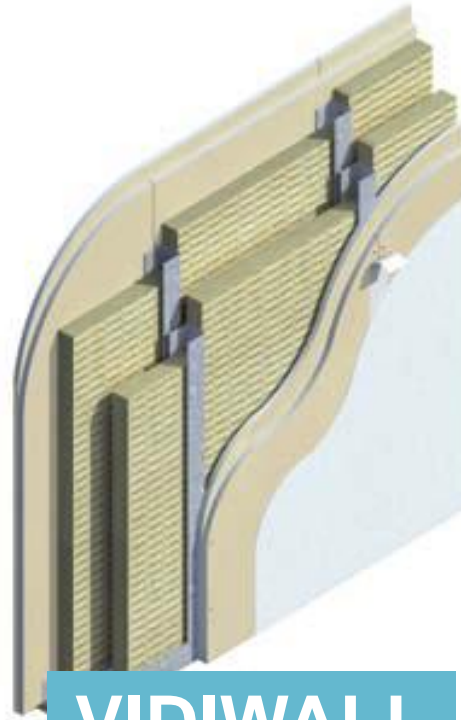

**VIDIWALL**

Rw 67 dB

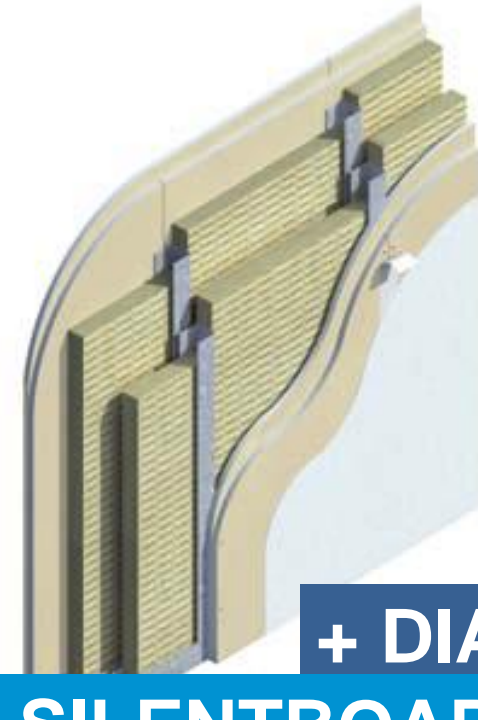

**SILENTBOARD**

**+ DIAMANT**

Rw 74 dB





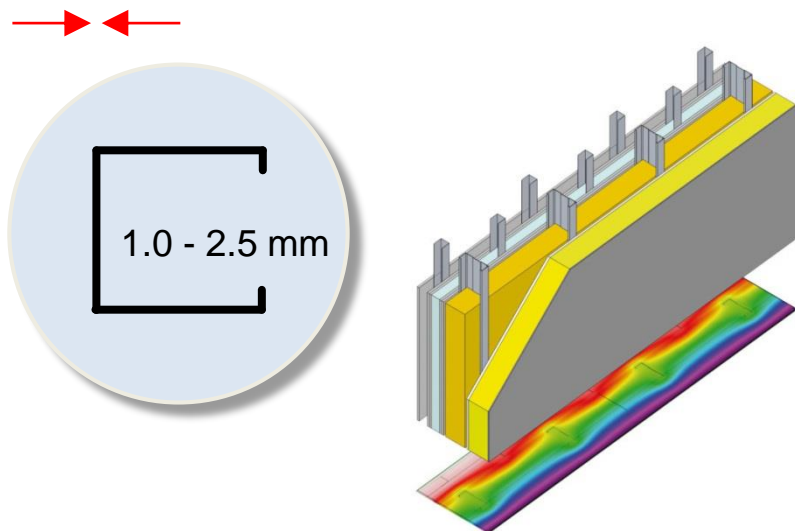



[tour.edilportale.com](http://tour.edilportale.com)



# edilportale<sup>®</sup>

## TOUR 2018

grazie per l'attenzione

[tour.edilportale.com](http://tour.edilportale.com)

